

RC series Thick Film Low Ohm Chip Resistor

◆ Features

- » Low inductance
- » Highly reliable multilayer electrode construction
- » Higher component and equipment reliability
- » Reduced size of final equipment reliability

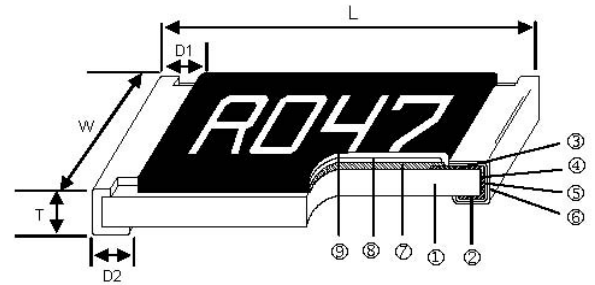

◆ Applications

- » Power Management Applications
- » Switching Power Supply
- » Over Current Protection in Audio Application
- » Voltage Regulation Module (VRM)
- » DC-DC Converter, Battery Pack, Charger Adaptor
- » Automotive Engine Control
- » Disk Driver

◆ Configuration

1	Alumina Substrate	6	External Electrode
2	Bottom Electrode	7	Resistor Layer
3	Top Electrode	8	Primary Overcoat
4	Edge Electrode	9	Secondary Overcoat
5	Barrier Layer		

◆ Dimension

Unit: mm

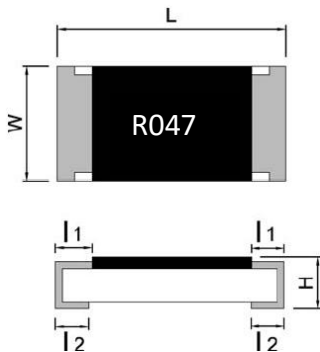

RC0402 / RC0603 / RC0805 / RC1206
RC1210 / RC1812 / RC2010 / RC2512

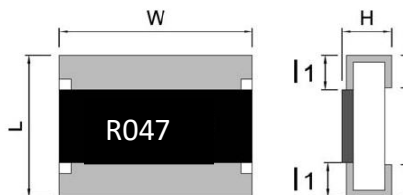

RC1218

TYPE	L	W	H	I1	I2
RC0402	1.00±0.01	0.50±0.05	0.30±0.05	0.20±0.10	0.25±0.10
RC0603	1.60±0.10	0.80±0.10	0.45±0.10	0.30±0.15	0.30±0.15
RC0805	2.00±0.10	1.25±0.10	0.50±0.10	0.35±0.20	0.35±0.15
RC1206	3.05±0.10	1.55±0.10	0.55±0.15	0.45±0.20	0.35±0.15
RC1210	3.05±0.10	2.55±0.10	0.55±0.10	0.50±0.20	0.50±0.20
RC1812	4.50±0.10	3.00±0.10	0.55±0.05	0.55±0.20	0.70±0.20
RC2010	5.00±0.20	2.50±0.20	0.55±0.10	0.60±0.20	0.60±0.20
RC1218	3.10±0.10	4.60±0.10	0.55±0.05	0.40±0.20	0.50±0.20
RC2512	6.40±0.20	3.20±0.20	0.60±0.15	0.60±0.25	0.90±0.25

◆ Standard Electrical Specifications

TYPE	Power Rating At 70°C (W)	Max Working Voltage	Max Overload Voltage	TCR (ppm/°C) Lower available	Resistance Range (mΩ)	
					1%	5%
RC0402	1/16 W (0.063 W)	0.25V	0.624V	±1000	50~990	50~990
RC0603	1/10 W (0.1 W)	0.31V	0.775V	±1200	20~47	20~47
				±1000	50~330	50~330
				±600	332~510	332~510
				±600	511~990	511~990
RC0805	1/8 W (0.125 W)	0.35V	0.875V	±1800	10~18	10~18
				±1800	20~50	20~50
				±800	51~99	51~99
				±600	100~330	100~330
				±600	332~990	332~990
RC1206	1/4 W (0.25 W)	0.5V	1.25V	±1800	10~18	10~18
				±1800	20~47	20~47
				±800	50~91	50~91
				±600	100	100
				±600	102~990	102~990
RC1210	1/2 W (0.5 W)	0.57V	1.425V	±1800	10~18	10~18
				±800	20~91	20~91
				±600	100	100
				±600	102~990	102~990
RC1812	3/4 W (0.75 W)	0.7V	1.75V	±1800	10~50	10~50
				±800	51~100	51~100
				±600	101~330	101~330
				±600	332~990	332~990
RC2010	3/4 W (0.75 W)	0.7V	1.75V	±1800	10~18	10~18
				±800	20~100	20~100
				±600	102~330	102~330
				±600	332~990	332~990
RC1218	1 W	0.99V	2.475V	±1800	10~50	10~50
				±800	51~990	51~990
RC2512	1W	0.99V	2.475V	±1800	10~18	10~18
				±800	20~91	20~91
				±600	100	100
				±600	102~990	102~990

● Note: Lower TCR value is available for customer's requirement.

◆ High Power Electrical Specifications

TYPE	Power Rating At 70°C (W)	Max Working Voltage	Max Overload Voltage	TCR (ppm/°C) Lower available	Resistance Range (mΩ)	
					1%	5%
RC0402	1/10 W (0.1 W)	0.25V	0.624V	±1000	50~91	50~91
				±800	100~976	100~976
RC0603	1/8 W (0.125 W)	0.352V	0.879V	±1200	20~47	20~47
				±1000	50~91	50~91
RC0805	1/4 W (0.25 W)	0.497V	1.244V	±600	100~990	100~990
				±1800	10~18	10~18
RC0805	1/4 W (0.25 W)	0.497V	1.244V	±1800	20~47	20~47
				±800	50~91	50~91
RC0805	1/4 W (0.25 W)	0.497V	1.244V	±600	100~990	100~990
				±1800	10~18	10~18
RC1206	1/2 W (0.5 W)	0.704V	1.759V	±1800	20~47	20~47
				±1800	10~18	10~18
RC1206	1/2 W (0.5 W)	0.704V	1.759V	±800	50~91	50~91
				±600	100~990	100~990
RC1210	2/3 W	0.808V	2.021V	±1800	10~18	10~18
				±800	20~91	20~91
RC1210	2/3 W	0.808V	2.021V	±600	100~900	100~900
				±1800	10~50	10~50
RC1812	1 W	0.995V	2.487V	±800	51~100	51~100
				±600	101~330	101~330
RC1812	1 W	0.995V	2.487V	±600	331~990	331~990
				±1800	10~18	10~18
RC2010	1W	0.995V	2.487V	±800	20~91	20~91
				±600	100~900	100~900
RC2512	2W	1.407V	3.518V	±1800	10~18	10~18
				±800	20~91	20~91
RC2512	2W	1.407V	3.518V	±600	100~900	100~900

● Note: Lower TCR value is available for customer's requirement.

◆ Part Number

RC	0603	J	0R47	□	□□	
Type	Size	Tolerance	R VALUE	Reel Size	Package Quantity	Rated Power
RC	0402	J=5%	47mΩ= 0R47	Blank = 7"	(Standard Package As below)	Blank = normal
	0603	F=1%	0.1Ω= 0R1	B= 13"	10 = 10K per reel	V= 1/4W
	0805			C= 10"	20 = 20K per reel	U= 1/2W
	1206				08= 8K per reel	T = 1W
	1210				16= 16K per reel	S = 2W
	1218					
	2512					

» Standard Package Q'ty for each size is as following.

TYPE	Standard Package Q'ty
RC0402	10K per reel
RC0603	5K per reel
RC0805	5K per reel
RC1206	5K per reel
RC1210	5K per reel
RC1812	4K per reel
RC2010	4K per reel
RC1218	4K per reel
RC2512	4K per reel

◆ Specification

Specification and Test Methods

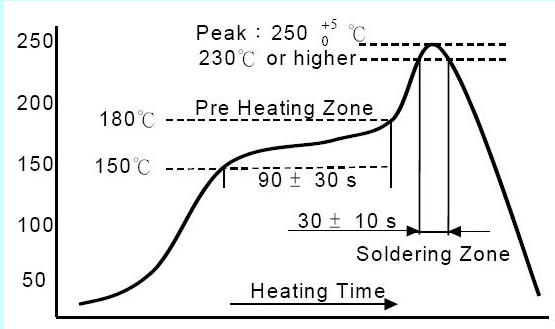
TEST ITEM	TEST METHOD	SPECIFICATON	REQUIREMENTS
Temperature Coefficient of Resistance (T.C.R)	JIS C 5201-1 clause 4.8	-55°C ~+155°C, 20°C is the reference temperature	Refer to Ratings
Short Time Overload	JIS C 5201-1 clause 4.13	General : 2.5 times RCWV or Max. Overload voltage for 5 seconds. High Power : 2.5 times RCWV or Max. Overload voltage for 2 seconds.	±1% : ±(1.0%+0.05Ω) ±5% : ±(2.0%+0.1Ω)
IR Reflow	Sony SS-00254	 <p>The graph shows a temperature profile for IR reflow. The y-axis is temperature in °C (50 to 250) and the x-axis is Heating Time. Key points include: a peak of 250°C (with a tolerance of +5°C) or higher; a pre-heating zone starting at 180°C; a temperature of 150°C reached after 90 ± 30 seconds; and a soldering zone with a duration of 30 ± 10 seconds.</p>	±1% : ±(1.0%+0.05Ω) ±5% : ±(1.0%+0.05Ω)
Leaching	Sony SS-00254-9	260±5°C for 30 seconds.	>95% Coverage
Soldering Heat	JIS C 5201-1 clause 4.18	260±5°C for 10 seconds.	±1% : ±(0.5%+0.05Ω) ±5% : ±(1.0%+0.05Ω)
Temperature Cycling	JIS C 5201-1 clause 4.19	-55°C to +155°C, 5 cycles	±1% : ±(0.5%+0.05Ω) ±5% : ±(1.0%+0.10Ω)
Electric Iron	Sony SS-00254-5	Preheating temperature : 350±10°C Electric iron preheating time : 3+1/-0 sec	±1% : ±(1.0%+0.05Ω) ±5% : ±(1.0%+0.05Ω)
Resistance to Solvent	JIS C 5201-1 clause 4.29	The tested resistor be immersed into isopropyl alcohol of 20~25°C for 60 secs. Then the resistor is left in the room for 48 hrs.	±1% : ±(0.5%+0.05Ω) ±5% : ±(0.5%+0.05Ω)
Load Life in Humidity	JIS C 5201-1 clause 4.24	40±2°C, 90~95% R.H. or Max. working voltage for 1000 hrs with 1.5 hrs "ON" and 0.5 hr "OFF" .	±1% : ±(0.5%+0.05Ω) ±5% : ±(2.0%+0.05Ω)
Load Life (Endurance)	JIS C 5201-1 clause 4.25	70±2°C, or Max. working voltage for 1000 hrs with 1.5 hrs "ON" and 0.5 hr "OFF" .	±1% : ±(1.0%+0.05Ω) ±5% : ±(3.0%+0.10Ω)
Terminal Bending Strength	JIS C 5201-1 clause 4.33	Bending once for 5 seconds D : 0402、0603、0805=5mm 1206、1210、1812=3mm 1218、2010、2512=2mm	±1% : ±(1.0%+0.05Ω) ±5% : ±(1.0%+0.05Ω)
Insulation Resistance	JIS C 5201-1 clause 4.6	Max. Overload voltage for 1 minute.	≥ 10GΩ

◆ Packing

Tape Dimension

» Paper Carrier

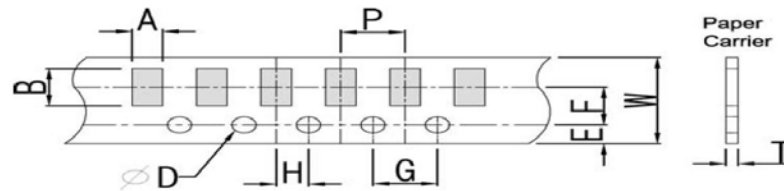

Unit: mm

TYPE	A	B	W	E	F	G	H	T	ϕD	P
RC0402	0.70± 0.1	1.20± 0.1	8.0± 0.2	1.75± 0.1	3.5± 0.05	4.0± 0.1	2.0± 0.05	0.45± 0.1	1.5± 0.1	2.0± 0.1
RC0603	1.05± 0.2	1.80± 0.2	8.0± 0.2	1.75± 0.1	3.5± 0.05	4.0± 0.1	2.0± 0.05	0.60± 0.1	1.5± 0.1	4.0± 0.1
RC0805	1.55± 0.2	2.30± 0.2	8.0± 0.2	1.75± 0.1	3.5± 0.05	4.0± 0.1	2.0± 0.05	0.75± 0.1	1.5± 0.1	4.0± 0.1
RC1206	1.90± 0.2	3.50± 0.2	8.0± 0.2	1.75± 0.1	3.5± 0.05	4.0± 0.1	2.0± 0.05	0.75± 0.1	1.5± 0.1	4.0± 0.1
RC1210	2.85± 0.2	3.50± 0.2	8.0± 0.2	1.75± 0.1	3.5± 0.05	4.0± 0.1	2.0± 0.05	0.75± 0.1	1.5± 0.1	4.0± 0.1

» Embossed Carrier

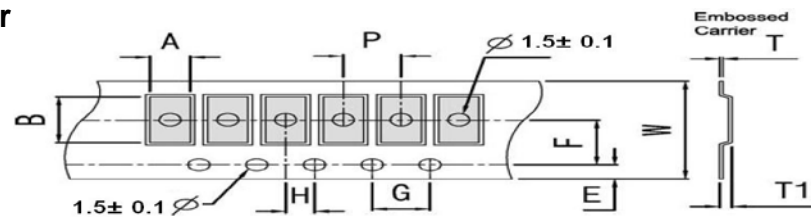

Unit: mm

TYPE	A	B	W	E	F	G	H	T	T1	P
RC1812	3.30± 0.2	4.60± 0.2	12.0± 0.2	1.75± 0.1	5.5± 0.05	4.0± 1	2.0± 0.05	0.23± 0.1	0.85± 0.15	4.0± 0.1
RC2010	2.80± 0.2	5.60± 0.2	12.0± 0.2	1.75± 0.1	5.5± 0.05	4.0± 1	2.0± 0.05	0.23± 0.1	0.85± 0.15	4.0± 0.1
RC1218	3.30± 0.2	4.60± 0.2	12.0± 0.2	1.75± 0.1	5.5± 0.05	4.0± 1	2.0± 0.05	0.23± 0.1	0.85± 0.15	4.0± 0.1
RC2512	3.40± 0.2	6.70± 0.2	12.0± 0.2	1.75± 0.1	5.5± 0.05	4.0± 1	2.0± 0.05	0.23± 0.1	0.85± 0.15	4.0± 0.1

Lead Dimensions

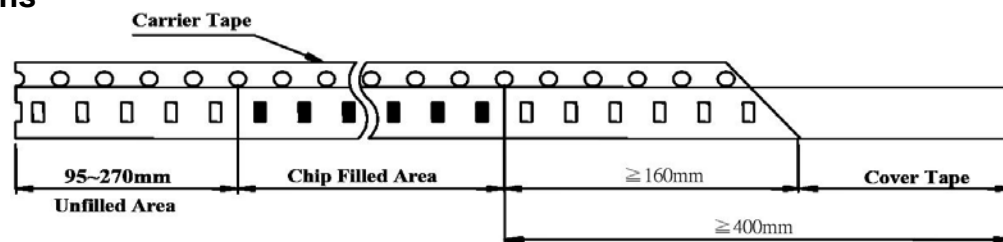

Top Adhesive Peel Off Strength : 10~70g

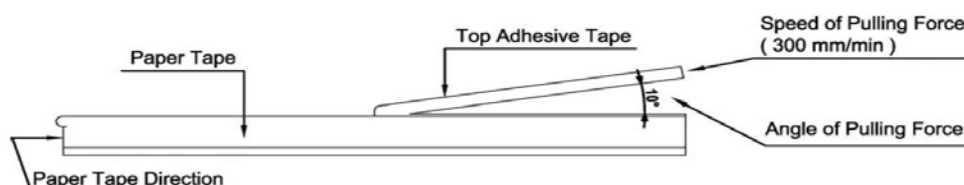

◆ Packing
Reel Dimensions

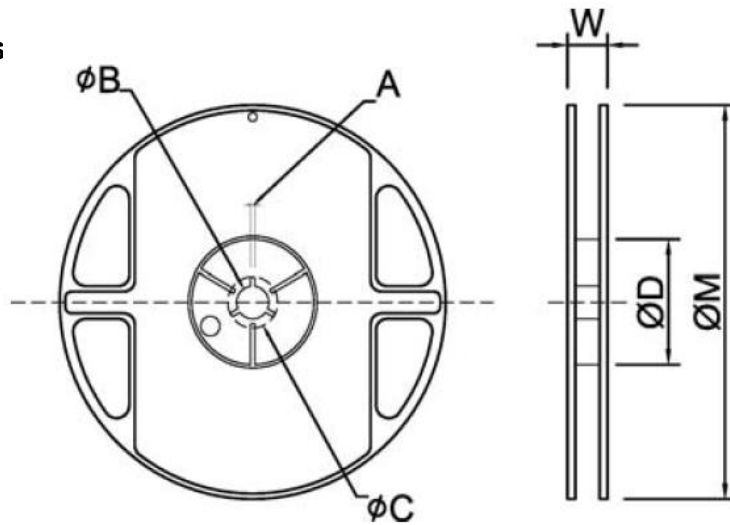

Unit: mm

TYPE	SIZE		A	ϕB	ϕC	ϕD	W	ϕM
RC0402	7"	10K/Reel	2.0±0.5	13.5±1.0	21±1.0	60±1.0	11.5±2.0	178±2.0
RC0603	7"	5K/Reel	2.0±0.5	13.5±1.0	21±1.0	60±1.0	11.5±2.0	178±2.0
RC0805								
RC1206								
RC1210								
RC1812	7"	4K/Reel	2.0±0.5	13.5±1.0	21±1.0	60±1.0	16.0±2.0	178±2.0
RC2010								
RC1218								
RC2512								